

YUEQING HONGYI ELECTRONICS CO., LTD
乐清市宏一电子有限公司

SPECIFICATION FOR APPROVAL

承认书

CUSTOMER 客户名称	
DESCRIPRION 产品名称	2.0 排针、PAE、30 防水套系列连接器
ITEM NO 编 号	HY-D0005 (D05)
DATE 日 期	2022-09-11

CUSTOMER ACKNOWLEDGEMENT SEAL

客户承认印签

(APPROVAL) 核准	(ENGINEERING) 工程	(PURCHASE) 采购	(QUALITY) 品质
承认结果： <input type="checkbox"/> 通过 <input type="checkbox"/> 不通过 <input type="checkbox"/> 重新送样			

IS09001

IS014001

IS045001

IATF16949 体系认证

ADD: No. 30, Wenjing Road, Houyu village, Shifan street, Yueqing City, Zhejiang Province

地址：浙江省乐清市石帆街道后屿文景路 30 号

TEL:0577-62380521

FAX: 0577-62381979 P.C:325608

http: //www.zhehongyi.com

E-MAIL:yaohongxiao88@126.com

产 品 承 认 书 目 录

1、封面	1-1
2、修订履历	2-2
2、目录	3-3
3、技术规范	4-9
4、产品图纸	10-14

PRODUCT SPECIFICATION

产品规范

1、Scope

适用范围

This specification includes the following specifications for 2.0 pin, PAE, and waterproof sleeve series connectors

本规范包括下列 2.0 排针、PAE、防水套系列连接器规格说明

2、Appearance and Dimension

外观及尺寸

2.1 Appearance:Product surface without defect、dirt、crack、and mechanical damang,Contactwithout rust,plating not oxidized and not peeled.

产品表面不应有对制品有害的缺陷、污垢、裂痕及机械损伤；接触件无锈蚀、镀层氧化脱落等现象

2.2 Dimension:According to drawings

外形尺寸：依照附图

3、Disposal of Material and surface

材料与表面处理

Specification 规格内容	Material 材质	Finish 表面处理	Environmental protection grade 环保等级	
Terminal 端子	Phosphor bronze 磷铜 厚 0.20mm	Tin Plating:2.5-5 μm 镀锡：2.5-5 μm	RoHS2.0	
Housing 胶壳	PA66 UL94V-0	Color: White 颜色：白色		
Wafer 针座	Plastic 塑壳	PA66 UL94V-0		Color:White 颜色：白色
	Contact 插针	Brass 黄铜 厚 0.50mm		Tin Plating:2.5~5 μm 镀锡：2.5~5 μm
Waterproof sleeve 防水套	PA66 UL94V-0	Color:Grey 颜色：灰色		

4、Ratings and applicable wires

额定等级

Item 项目	Standard 规格
Rated Voltage 额定电压	250V AC/DC
Rated Current 额定电流	3A AC/DC
Ambient temperature Range 使用温度范围	-25°C- +85°C
Applicable wire insulation 适用线径	AWG22#-28#

5、Electrical Performance

电气性能

N0. 序号	Ltem 项目	Test mode 试验方法	Requirement 技术要求
5.1	ContactResistance 接触电阻	Male female cooperation, open voltage less than 20mV, current 100mA detection connector at both ends 公母配合, 开放电压20mV 以下, 电流100mA 检测连接器连接器两端	Initial:20mΩ Max 初始: 20mΩ Max After Test: 30mΩ Max 试验后: 30mΩ Max
5.2	withstandvoltage 耐电压	Mate connectors, apply 800V AC for 1 minute between adjacent terminal or ground 公母配合, 在相邻端子, 端子与地片之间, 使用800V 的交流电1 分钟, 检测连接器	No Breakdown and Flashover 外观无损伤, 无打火花
5.3	InsulationResistance 绝缘电阻	Mate connectors, apply 500V DC between adjacent terminal or ground 公母配合, 在相邻端子, 端子与地片之间, 使用500V 的直流电, 检测连接器	1000MΩ Min

6、机械性能

Mechanical Performance

NO. 序号	Item 项目	Test mode 试验方法		Requirement 技术要求
6.1	Terminal crimping wire strength 端子压接导线强度	Fix the crimped terminal, apply axial pull out force on thewire 固定铆线后的端子, 使电线与端 子分离时所需的最小力量	AWG#22 wire AWG#22 导线	40N Min
			AWG#24 wire AWG#24 导线	30N Min
			AWG#26 wire AWG#26 导线	20N Min
			AWG#28 wire AWG#28 导线	13N Min
6.2	Terminal/ Housing Retention Force 端子保持力	Apply axial pull out force at the speed rate of 25.4±3mm/minute on the terminal assembled in the Housing 以每分 25.4±3mm 的速率, 将端子从 Housing 内 轴向拔出		Per contact: 15N Min 单一接触点: 15N Min
6.3	Insertion & withdraw Force 插拔力	Insert and withdraw Connectors at the speed rate of 25.4±3mm/minute 以每分 25.4±3mm 的速率插入和拔出		Refer to paragraph 8 参照第 8 项
6.4	Pin Retention Force Pin 针保持力	Apply axial push force at the speed rate of 25.4±3mm/minute 以每分 25.4±3mm 的速率, 将 PIN 针从 Wafer 内轴向拔出		Per contact: 10N Min 单一接触点: 10N Min

7、Endurance Characteristics:

环境性能

NO. 序号	Ltem 项目	Test mode 试验方法	Requirement 技术要求	
7.1	Repeated Insertion/ Withdrawal 重复插拔	When mated up to 30 cycles repeatedly by the rate of 10 cycles per minute 以每分钟不超过 10 次的速率, 将公母插拔 30 次	Contact Resistance 接触电阻	30 mΩ Max
7.2	Temperature Rise 温升测试	Mating connectors shall be energized at rating current until thermal stability is achieved, and then measured the temperature rise 公母连接器配合后, 加载额定电流直到温度上升到稳定 状态, 然后再测量温升	Temperature Rise 温升测试	30°C Max
7.3	Vibration test 振动测试	Amplitude: 1.5mm P-P Sweep time: 10~55~10 HZ in 1 minute Duration: 2 hours in each X.Y.Z axials 振幅: 1.5mm P-P 时间: 10~55~10 HZ in 1 minute 持续时间: 每轴向 2 小时	Appearance 外观	No damage 无异常
			Contact Resistance 接触电阻	30 mΩ Max
			Discontinuity 瞬断	1 micro- second Max.
7.4	Heat Resistance 耐热性	85±2°C, 96 hours	Appearance 外观	No damage 无异常
			Contact Resistance 接触电阻	30 mΩ Max
7.5	Cold Resistance 耐寒性	-25±3°C, 96 hours	Appearance 外观	No damage 无异常
			Contact Resistance 接触电阻	30 mΩ Max
7.6	Humidity 耐湿性	Temperature: 60±2°C Relative Humidity: 90~95% Duration: 96 hours 温度: 60±2°C 湿度: 90~95%(RH) 持续时间: 96 hours	Appearance 外观	No damage 无异常
			Contact Resistance 接触电阻	30 mΩ Max
			Withstand Voltage 耐电压	No Breakdown and Flashover 外观无损伤, 无打火花
			Insulation Resistance 绝缘电阻	1000MΩ Min

NO. 序号	Ltem 项目	Test mode 试验方法	Requirement 技术要求	
7.7	温度变化 Temperature Cycling	5 cycles of: a) -25°C 30 minutes b) +85°C 30 minutes	Appearance 外观	No damage 无异常
		从-25°C持续30 分钟升至+85°C持续30 分钟, 循环5 次	Contact Resistance 接触电阻	30 mΩ Max
7.8	Salt spray 盐雾	24±1 hours exposure to a salt spray from the 5±1% solution at 35±2°C	Appearance 外观	No damage 无异常
		在温度35±2°C, 盐水浓度5±1%下, 盐水喷雾24±1 小时	Contact Resistance 接触电阻	30 mΩ Max
7.9	Solderability 焊锡附着性	Soldering Time: 3-5sec solder Temperature: 245±5°C 焊接时间: 3-5 秒 焊接温度: 245±5°C	Solder Wetting 焊料润湿	Immersion area above 95% 浸渍面积 95% 以上
7.10	Solder- Resistance 焊锡耐热性	DIP type PA66 material welding heat resistance range: Soldering time:3~5sec solder. Temperature:230±5°C DIP 型 PA66 材质焊接耐热范围: 焊接时间: 3~5 秒. 焊接温度: 230±5°C DIP type PA6T material welding heat resistance range: Soldering time:3~5sec solder. Temperature:245±5°C DIP 型 PA6T 材质焊接耐热范围: 焊接时间: 3~5 秒. 焊接温度: 245±5°C	Appearance 外观	No damage 无异常

版本 REV.	日期 DATE	ECN NO.	变更内容 DESCRIPTION	制图 DRAWN

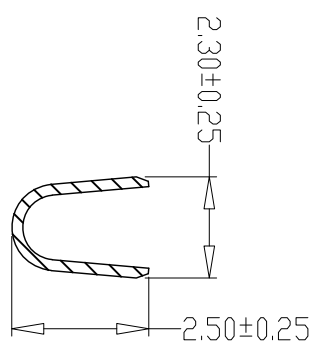
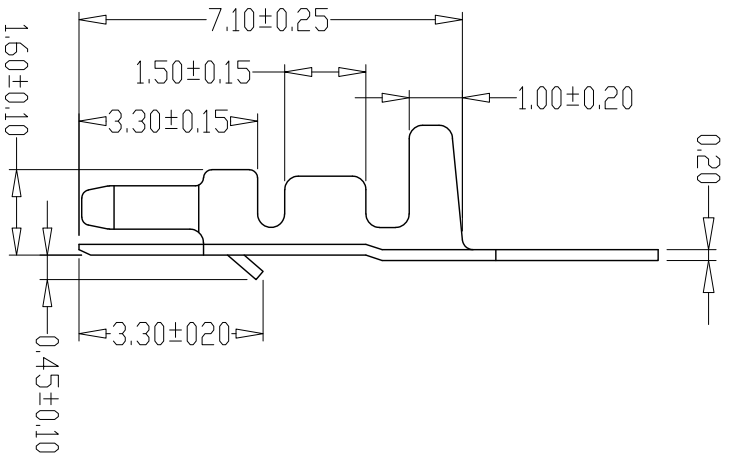
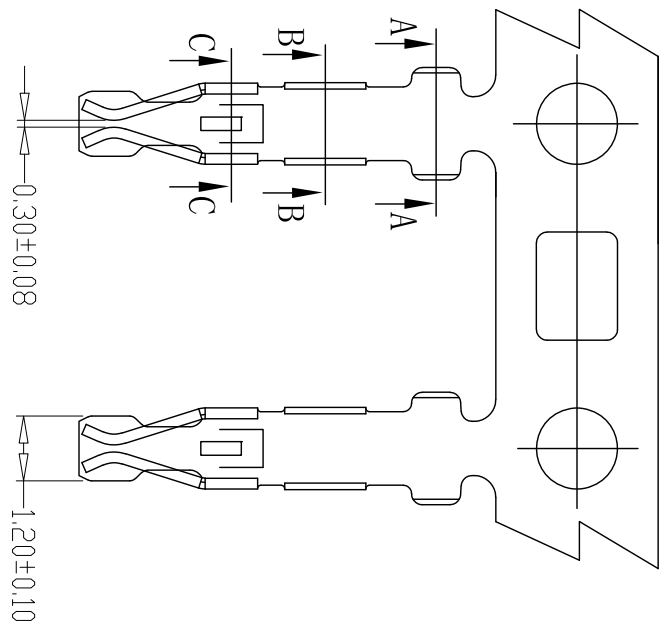

SEC: A-A

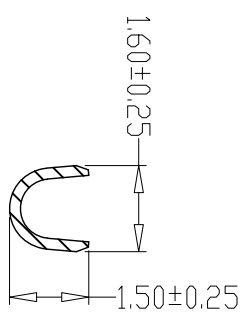

SEC: B-B

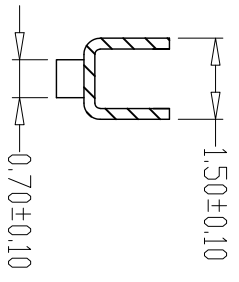

SEC: C-C

SPECIFICATIONS

- 1、Current Rating: 3A AC, DC
- 2、Voltage Rating: 250V AC, DC
- 3、Temperature Range: -25°C~+85°C
- 4、Contact Resistance: 20mΩ Max
- 5、Insulation Resistance: 1000MΩ Min
- 6、Withstanding Voltage: 800V AC/minute
- 7、Material: Phosphoric bronze Tin-plated
- 8、Applicable Wire Sizes: AWG#22~28#

GENERAL TOLERANCE		制图 Mapping	料号 PART NO.	版本 REV.
X.±0.25	X.±2°	张迎春 2022. 09. 10	D0005-T	A
.X±0.20	.X±1°	审核 钱岳生 2022. 09. 10	品名 PAE端子	页次 1/1
.XX±0.15	.XX±0.5°	核准 张名 2022. 09. 11	客户料号 CUST. NO.	SHEET
.XXX±0.10	.XXX±0.5°	单位 Units	比例 SCALE	1:1

乐清市宏一电子有限公司
YueQing HongYi Electronics Co., Ltd

版本 REV.	日期 DATE	ECN NO.	变更内容 DESCRIPTION	制图 DRAWN

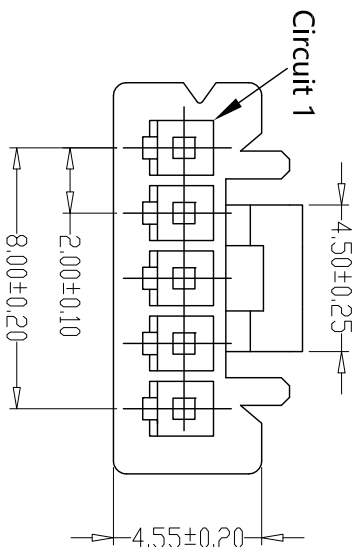
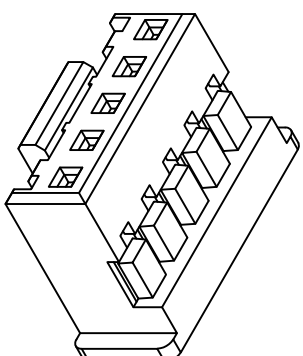

- SPECIFICATIONS
- 1、 Current Rating: 3A AC, DC
 - 2、 Voltage Rating: 250V AC, DC
 - 3、 Temperature Range: -25°C ~ +85°C
 - 4、 Contact Resistance: 20mΩ Max
 - 5、 Insulation Resistance: 1000mΩ Min
 - 6、 Withstanding Voltage: 800V AC/minute
 - 7、 Material: PA66, UL94V-0

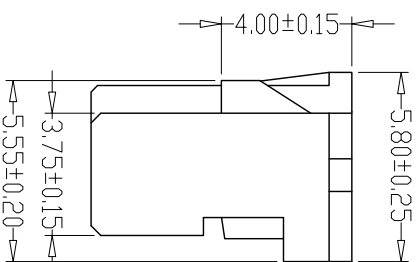
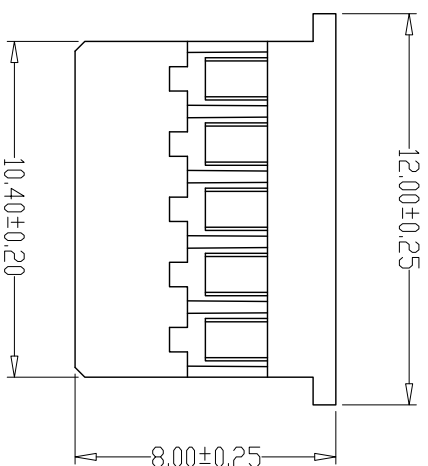

GENERAL TOLERANCE		制图 Mapping	张迎春	料号 PART NO.	D0005-5Y	版本 REV.	A
X.±0.25	X.±2°	审核 Audit	钱岳生	品名 TITLE	PAE孔座	页次 SHEET	1/1
.X±0.20	.X±1°	核准 Approved	张名	客户料号 CUST. NO.			
.XX±0.15	.XX±0.5°	单位 Units	2022. 09、 11				
.XXX±0.10	.XXX±0.5°	MM	SCALE				
		比例 SCALE	1:1				

乐清市宏一电子有限公司
Yueqing Hongyi Electronics Co., Ltd

版本 REV.	日期 DATE	ECN NO.	变更内容 DESCRIPTION	制图 DRAWN
------------	------------	---------	---------------------	-------------

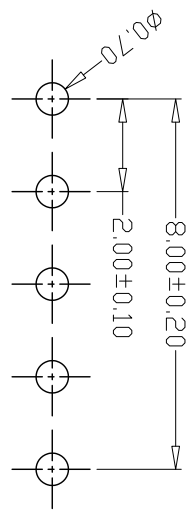
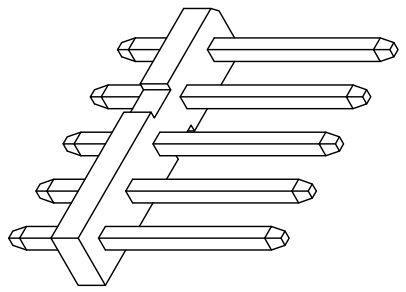
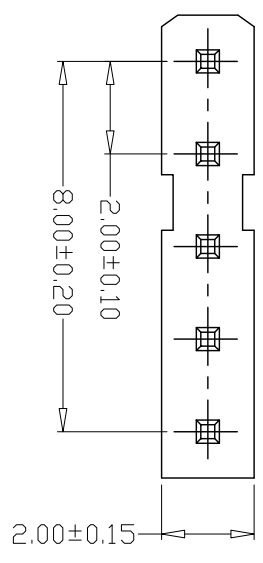

PCB LAYOUT

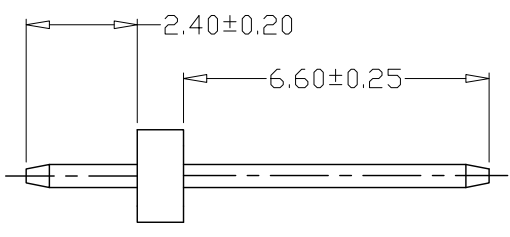
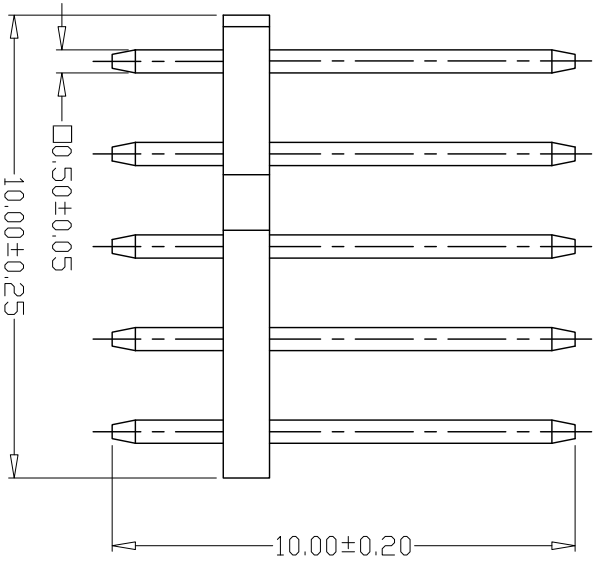

SPECIFICATIONS

- 1、Current Rating: 3A AC, DC
- 2、Voltage Rating: 250V AC, DC
- 3、Temperature Range: -25°C~+85°C
- 4、Contact Resistance: 20mΩ Max
- 5、Insulation Resistance: 1000MΩ Min
- 6、Withstanding Voltage: 800V AC/minute
- 7、Material: Wafer PA66, UL94V-0
PIN Brass Tin-plated

GENERAL TOLERANCE		制图 Mapping	张迎春	料号 PART NO.	D00005-5A	版本 REV.	A
X±0.25	X°±2°	审核 Audit	钱岳生	品名 TITLE	2.0排(直)针 WAFFER DIP TYPE	页次 SHEET	1/1
X±0.25	X°±1°	核准 Approved	张名	客户料号 CUST. NO.			
.XX±0.15	.XX°±0.5°	单位 Units	2022. 09. 11	比例 SCALE	1:1		
.XXX±0.10	.XXX°±0.5°	MM				乐清市宏一电子有限公司 YueDing HongYi Electronics Co., Ltd	

版本 REV.	日期 DATE	ECN NO.	变更内容 DESCRIPTION	制图 DRAWN
------------	------------	---------	---------------------	-------------

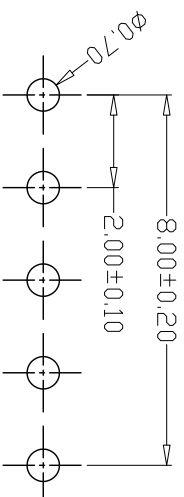
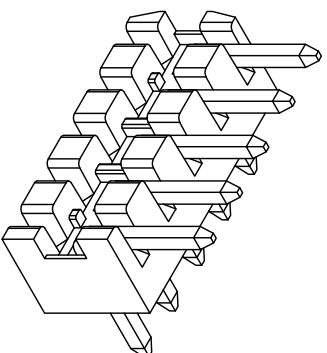
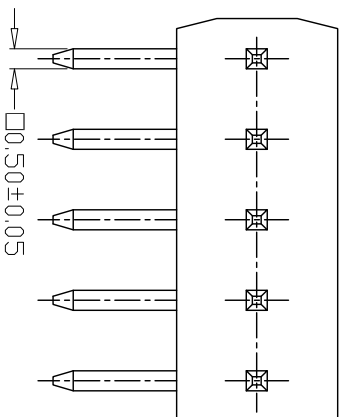

PCB LAYOUT

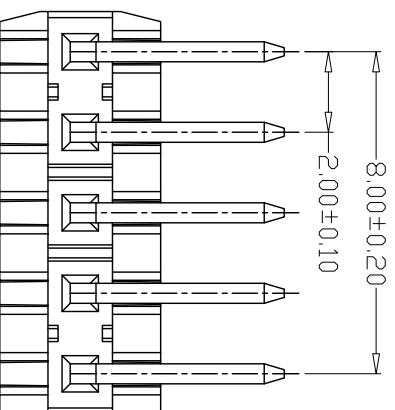
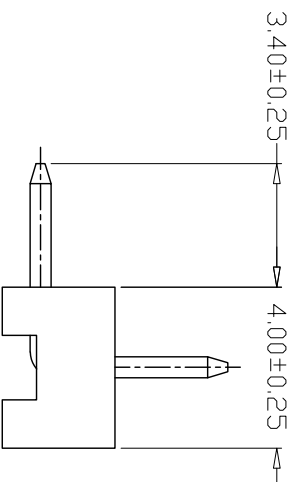
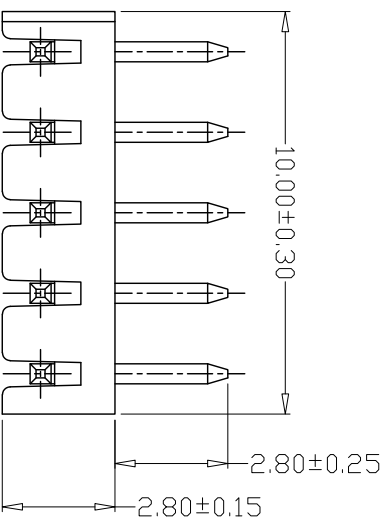

SPECIFICATIONS

- 1、Current Rating: 3A AC, DC
- 2、Voltage Rating: 250V AC, DC
- 3、Temperatuer Range: -25°C~+85°C
- 4、Contact Resistance: 20mΩ Max
- 5、Insulation Resistance: 1000MΩ Min
- 6、Withstanding Voltang: 800V AC/minute
- 7、Material: Wafer PA66, UL94V-0
PIN Brass Tin-plated

GENERAL TOLERANCE		制图 Mapping	张迎春	料号 PART NO.	D00005-5AW	版本 REV.	A
X ± 0.25	X° ± 2°	审核 Audit	钱岳生	品名 TITLE	2.0排(弯)针	页次	1/1
X ± 0.25	X° ± 1°	核准 Approved	张名	客户料号 WAFFER DTP TYPE		SHEET	
.XX ± 0.15	.XX° ± 0.5°	单位 Units	2022. 09. 11	CITM. NO.			
.XXX ± 0.10	.XXX° ± 0.5°	MM	SCALE	1:1	 乐清市宏一电子有限公司 YueDing HongYi Electronics Co., Ltd		

REV.	DATE	ECN NO.	变更内容 DESCRIPTION	制图 DRAWN

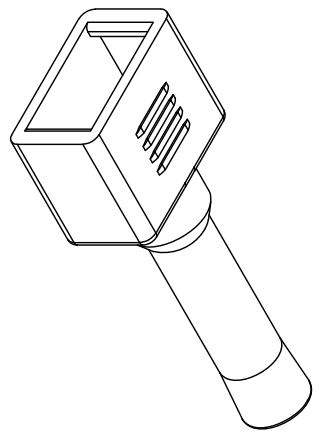

- SPECIFICATIONS**
- 1、 Current Rating: 3A AC, DC
 - 2、 Voltage Rating: 250V AC, DC
 - 3、 Temperature Range: -25°C~+85°C
 - 4、 Contact Resistance: 20mΩ Max
 - 5、 Insulation Resistance: 1000mΩ Min
 - 6、 Withstanding Voltage: 800V AC/minute
 - 7、 Material: silica gel

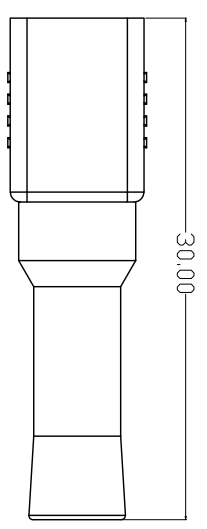
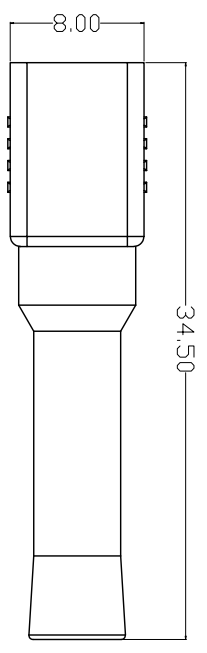
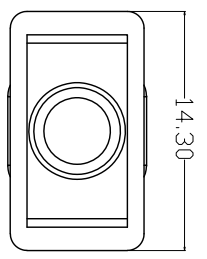
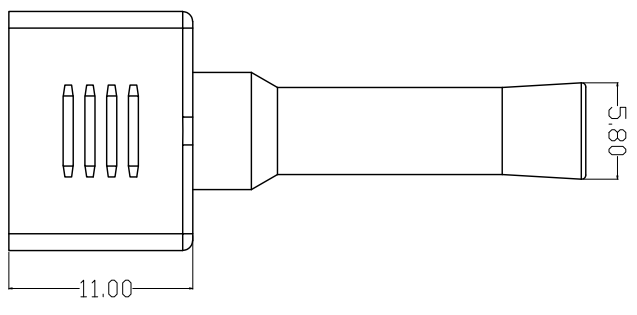

TYPE1

GENERAL TOLERANCE		制图 Mapping		料号 PART NO.		版本 REV.	
X.±0.25	X.±2°	张迎春	2022. 09、 10	D00005-5Y (防水套)	A		
.X±0.20	.X±1°	审核 钱岳生	2022. 09、 10	品名 防水套			
.XX±0.15	.XX±0.5°	核准	张名	客户料号			
.XXX±0.10	.XXX±0.5°	Approved	2022. 09、 11	CITM. NO.			
		单位 Units	MM	比例 SCALE	1:1		

配件参考图面，以实际为准

乐清市宏一电子有限公司
YueQing HongYi Electronics Co., Ltd